

K package: 1200V 450A IGBT module

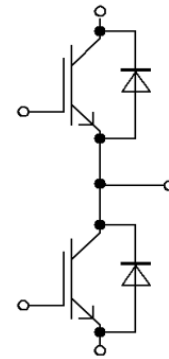

Equivalent Circuit Schematic

Features:

- 1200V 450A, $V_{CE(sat)} = 1.55V @ 25^{\circ}C$
- Trench/FS Technology
- Low Losses
- High RBSOA capability
- Low reverse-recovery losses

产品特性:

- 1200V 450A, $V_{CE(sat)} = 1.55V @ 25^{\circ}C$
- 沟槽栅/场终止技术
- 低损耗
- 高 RBSOA 能力
- 低反向恢复损耗

Typical Applications:

- High Power Converters
- Motor Drives
- Uninterrupted Power Supply
- Photovoltaic

典型应用:

- 大功率变流器
- 电机传动
- 不间断电源
- 光伏

IGBT, Inverter / IGBT , 逆变部分

Maximum Rated Values / 最大标称参数

Collector-emitter Voltage 集电极-发射极电压	$T_{vj}=25^{\circ}\text{C}$	V_{CES}	1200	V
Continuous DC collector current 集电极连续直流电流		$I_{C\text{ nom}}$	450	A
	$T_C=80^{\circ}\text{C}, T_{vj\text{ max}}=175^{\circ}\text{C}$	I_C	520	A
Repetitive Peak collector current 集电极可重复峰值电流	$I_{CRM}=2 \times I_{C\text{ nom}}$	I_{CRM}	900	A
Total power dissipation 总功率损耗	$T_C=25^{\circ}\text{C}, T_{vj\text{ max}}=175^{\circ}\text{C}$	P_{tot}	2025	W
Gate-emitter peak voltage 门极-发射极峰值电压		V_{GES}	± 20	V

Characteristic Values / 性能参数

			min.	typ.	max.		
Collector-emitter saturation Voltage 集电极-发射极饱和压降	$I_C=450\text{A}, V_{GE}=15\text{V}$	$T_{vj}=25^{\circ}\text{C}$	$V_{CE\text{ sat}}$	1.55	1.70	V	
	$I_C=450\text{A}, V_{GE}=15\text{V}$	$T_{vj}=125^{\circ}\text{C}$		1.70			
	$I_C=450\text{A}, V_{GE}=15\text{V}$	$T_{vj}=150^{\circ}\text{C}$		1.85			
	$I_C=450\text{A}, V_{GE}=15\text{V}$	$T_{vj}=175^{\circ}\text{C}$		1.90			
Gate Threshold Voltage 门极阈值电压	$V_{CE}=V_{GE}, I_C=18\text{mA},$	$T_{vj}=25^{\circ}\text{C}$	$V_{GE\text{ th}}$	5.0	6.0	7.0	V
Gate Charge 门极电荷	$V_{GE} = -15\text{ V} \dots +15\text{ V}$		Q_G		tbd		μC
Internal Gate Resistor 内置门极电阻	$T_{vj}=25^{\circ}\text{C}$		$R_{G\text{ int}}$		0.6		Ω
Input Capacitance 输入电容	$V_{CE} = 25\text{V}, V_{GE} = 0\text{V}$ $f = 1\text{MHz}$		C_{ies}		tbd		nF
Reverse Transfer Capacitance 反向传输电容			C_{res}		tbd		nF
Collector-emitter Cutoff Current 集电极-发射极关断漏电流	$V_{CE}=1200\text{V}, V_{GE}=0\text{V},$	$T_{vj}=25^{\circ}\text{C}$	I_{CES}			100	μA
Gate-emitter Leakage Current 门极-发射极漏电流	$V_{CE}=0\text{V}, V_{GE}=20\text{V},$	$T_{vj}=25^{\circ}\text{C}$	I_{GES}			100	nA
Turn-on Delay Time, Inductive Load 开通延迟时间, 感性负载	$I_C=450\text{A}, V_{CE}=600\text{V}$ $V_{GE}=15\text{V}/-8\text{V}$ $R_{G\text{ on}}=1.0\Omega$	$T_{vj}=25^{\circ}\text{C}$	t_{don}	275		ns	
		$T_{vj}=125^{\circ}\text{C}$		280			
		$T_{vj}=150^{\circ}\text{C}$		280			
		$T_{vj}=175^{\circ}\text{C}$		285			
Rise Time, Inductive Load 上升时间, 感性负载	$I_C=450\text{A}, V_{CE}=600\text{V}$ $V_{GE}=15\text{V}/-8\text{V}$ $R_{G\text{ on}}=1.0\Omega$	$T_{vj}=25^{\circ}\text{C}$	t_r	70		ns	
		$T_{vj}=125^{\circ}\text{C}$		80			
		$T_{vj}=150^{\circ}\text{C}$		85			
		$T_{vj}=175^{\circ}\text{C}$		90			
Turn-off Delay Time, Inductive Load 关断延迟时间, 感性负载	$I_C=450\text{A}, V_{CE}=600\text{V}$ $V_{GE}=15\text{V}/-8\text{V}$ $R_{G\text{ off}}=5.1\Omega$	$T_{vj}=25^{\circ}\text{C}$	t_{doff}	885		ns	
		$T_{vj}=125^{\circ}\text{C}$		940			
		$T_{vj}=150^{\circ}\text{C}$		970			
		$T_{vj}=175^{\circ}\text{C}$		1000			
Fall Time, Inductive Load 下降时间, 感性负载	$I_C=450\text{A}, V_{CE}=600\text{V}$ $V_{GE}=15\text{V}/-8\text{V}$ $R_{G\text{ off}}=5.1\Omega$	$T_{vj}=25^{\circ}\text{C}$	t_f	70		ns	
		$T_{vj}=125^{\circ}\text{C}$		155			
		$T_{vj}=150^{\circ}\text{C}$		170			
		$T_{vj}=175^{\circ}\text{C}$		190			

Turn-on energy loss per pulse 开通损耗	$I_C=450A, V_{CE}=600V$ $L_{\sigma}=45nH, V_{GE}=15V/-8V$ $R_{Gon}=1.0\Omega, di/dt =$ $3900 A/\mu s (T_{vj}=175^{\circ}C)$	$T_{vj}=25^{\circ}C$ $T_{vj}=125^{\circ}C$ $T_{vj}=150^{\circ}C$ $T_{vj}=175^{\circ}C$	E_{on}		30.5 45.0 49.5 58.5		mJ
Turn-off energy loss per pulse 关断损耗	$I_C=450A, V_{CE}=600V$ $L_{\sigma}=45nH, R_{Goff}=5.1\Omega$ $V_{GE}=15V/-8V, dv/dt =$ $4700 V/\mu s (T_{vj}=175^{\circ}C)$	$T_{vj}=25^{\circ}C$ $T_{vj}=125^{\circ}C$ $T_{vj}=150^{\circ}C$ $T_{vj}=175^{\circ}C$	E_{off}		40.0 53.0 56.0 68.0		mJ
SC Data 短路耐量	$V_{CE}=600V, V_{GE} =15V/-8V,$ $T_{vj}=150^{\circ}C$		t_{psc}	8			μs
Thermal Resistance, Junction to Case 结-壳热阻	Per IGBT/单个 IGBT		R_{thJC}		0.074		K/W
Temperature under switching conditions 工作温度			$T_{vj op}$	-40		150	$^{\circ}C$

Diode, Inverter / 二极管, 逆变部分

Maximum Rated Values / 最大标称参数

Repetitive peak reverse voltage 可重复反向峰值电压	$T_{vj}=25^{\circ}C$	V_{RRM}	1200	V
Continuous DC Forward Current 可连续正向直流电流		I_F	450	A
Repetitive Peak Forward Current 可重复正向峰值电流	$I_{CRM}=2 \times I_{Fnom}$	I_{FRM}	900	A

Characteristic Values / 性能参数

			min.	typ.	max.	
Forward Voltage 正向通态压降	$I_F=450A, V_{GE}=0V$ $I_F=450A, V_{GE}=0V$ $I_F=450A, V_{GE}=0V$ $I_F=450A, V_{GE}=0V$	$T_{vj}=25^{\circ}C$ $T_{vj}=125^{\circ}C$ $T_{vj}=150^{\circ}C$ $T_{vj}=175^{\circ}C$	V_F	1.90 1.85 1.85 1.70	2.40	V
Peak Reverse Recovery Current 反向恢复峰值电流	$I_F=450A, V_R=600V$ $-di_F/dt=3200A/\mu s, (T_{vj}=175^{\circ}C)$ $V_{GE}=-8V$	$T_{vj}=25^{\circ}C$ $T_{vj}=125^{\circ}C$ $T_{vj}=150^{\circ}C$ $T_{vj}=175^{\circ}C$	I_{RM}	235 280 290 290		A
Recovery Charge 反向恢复电荷	$I_F=450A, V_R=600V$ $-di_F/dt=3200A/\mu s, (T_{vj}=175^{\circ}C)$ $V_{GE}=-8V$	$T_{vj}=25^{\circ}C$ $T_{vj}=125^{\circ}C$ $T_{vj}=150^{\circ}C$ $T_{vj}=175^{\circ}C$	Q_R	17.0 44.5 52.0 59.5		μC
Reverse Recovery Energy 反向恢复损耗	$I_F=450A, V_R=600V$ $-di_F/dt=3200A/\mu s, (T_{vj}=175^{\circ}C)$ $V_{GE}=-8V$	$T_{vj}=25^{\circ}C$ $T_{vj}=125^{\circ}C$ $T_{vj}=150^{\circ}C$ $T_{vj}=175^{\circ}C$	E_{rec}	7.5 18.0 22.0 26.0		mJ
Thermal Resistance, Junction to Case 结-壳热阻	Per Diode / 单个 Diode		R_{thJC}	0.101		K/W
Temperature under switching conditions 工作温度			$T_{vj op}$	-40		150 $^{\circ}C$

Module / 模块

Isolation Test Voltage 绝缘测试电压	RMS, f=50Hz, t=1min	V_{ISOL}	3.0	KV
Material of Module Baseplate 模块底板材料			Cu	
Internal Isolation 内部绝缘	基本绝缘 (class 1, IEC 61140) Basic insulation (class1,IEC 61140)		Al ₂ O ₃	
Creepage Distance 爬电距离	端子-散热片 terminal to heatsink 端子-端子 terminal to terminal		29.0 23.0	mm
Clearance 电气间隙	端子-散热片 terminal to heatsink 端子-端子 terminal to terminal		23.0 11.0	mm
Comparative Tracking Index 相对漏电起痕指数		CTI	>400	

				min.	typ.	max.	
Stray Inductance Module 模块杂散电感		L_{sCE}		20			nH
Module Lead Resistance, Terminals-Chip 模块引脚电阻, 端子-芯片	$T_C = 25^\circ\text{C}$, 每个开关 per switch	R_{CC+EE}		0.50			mΩ
Storage Temperature 贮存温度		T_{stg}	-40		125		°C
Modul Mounting torque 模块安装扭距	M5	M	4.0		6.0		Nm
Terminal Mounting torque 端子安装扭距	M6	M	2.5		5.0		Nm
Weight 重量		G		320			g

- 1) Terminal impedance is not included.
不包含端子阻抗。

输出特性 IGBT, 逆变器(典型值)

Output characteristic IGBT Inverter (typical)

$I_C = f(V_{CE})$,

$V_{GE} = 15V$

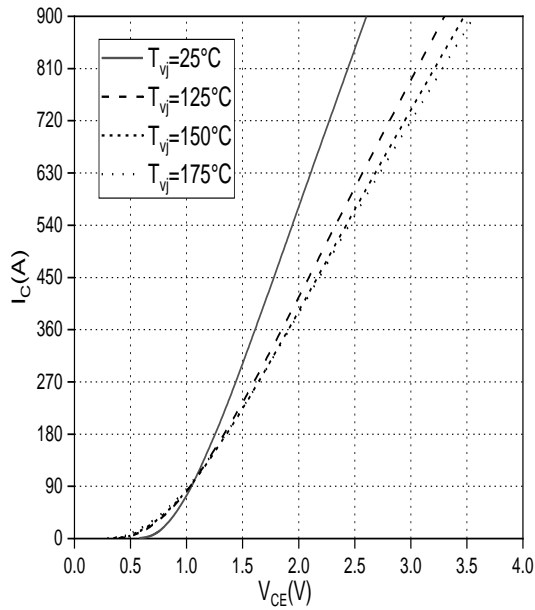

输出特性 IGBT, 逆变器(典型值)

output characteristic IGBT Inverter (typical)

$I_C = f(V_{CE})$,

$T_{vj} = 175^\circ\text{C}$

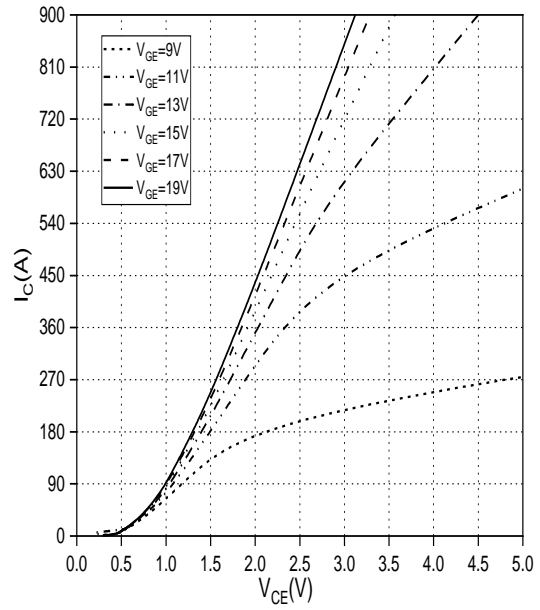

传输特性 IGBT, 逆变器 (典型值)

Transfer characteristic IGBT, Inverter (typical)

$I_C = f(V_{GE})$,

$V_{CE} = 20V$

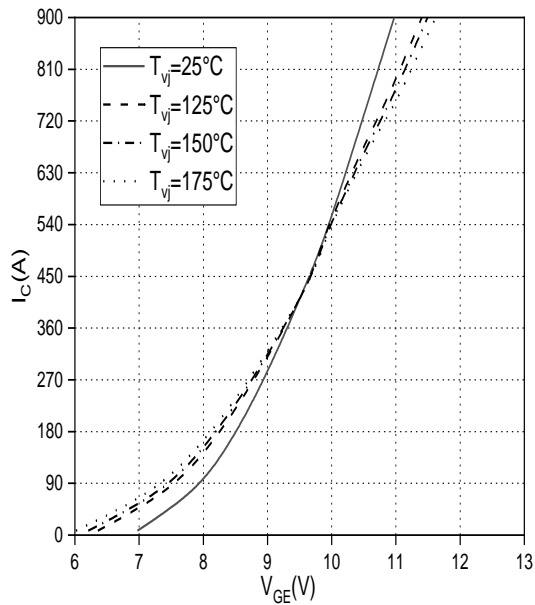

开关损耗 IGBT, 逆变器 (典型值)

switching losses IGBT, Inverter (typical)

$E_{on} = f(I_C), E_{off} = f(I_C), V_{GE} = 15V/-8V$,

$R_{Gon} = 1\Omega, R_{Goff} = 5.1\Omega, V_{CE} = 600V$

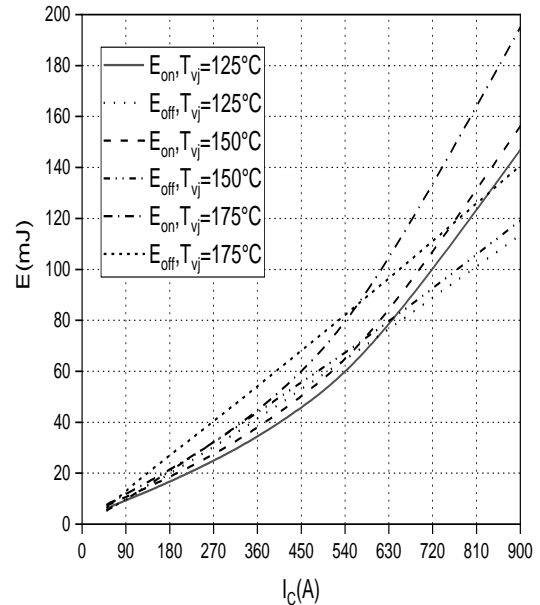

开关损耗 IGBT, 逆变器 (典型值)

Switching losses IGBT, Inverter (typical)

$V_{GE} = 15V/-8V, I_C = 450A, V_{CE} = 600V$

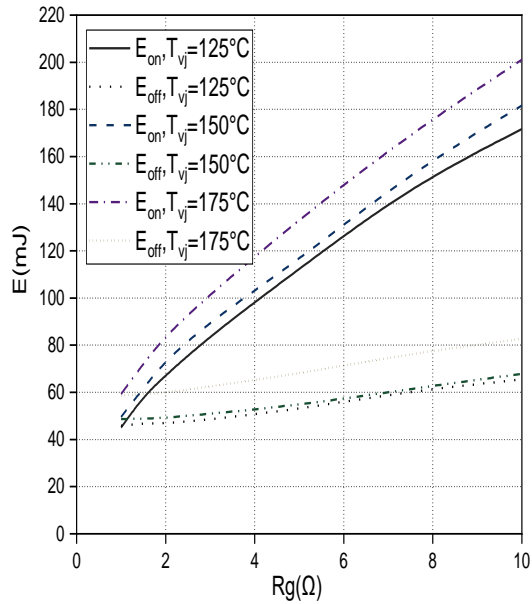

瞬态热阻抗 IGBT, 逆变器

transient thermal impedance IGBT, Inverter

$Z_{thJC} = f(t)$

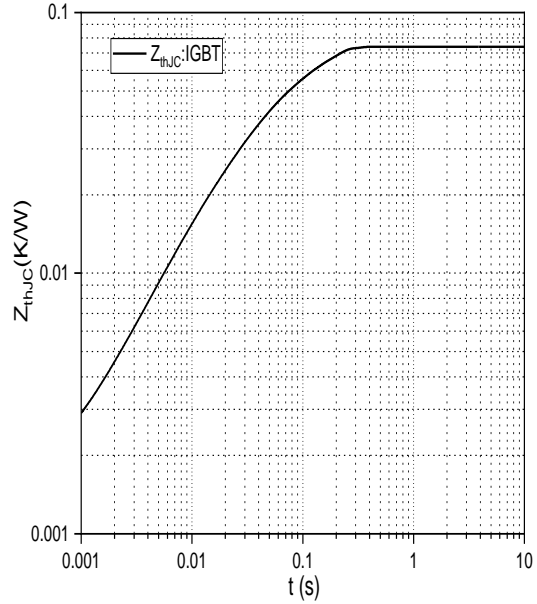

反偏安全工作区 IGBT, 逆变器 (RBSOA)

Reverse bias safe operating area IGBT, Inverter (RBSOA) $I_C = f(V_{CE})$,

$V_{GE} = 15V/-8V, R_{Goff} = 5.1\Omega, T_{vj} = 175^\circ C$

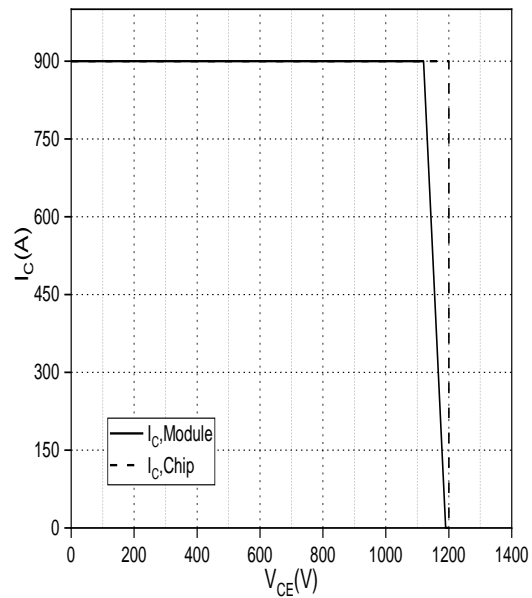

正向偏压特性二极管, 逆变器 (典型值)

forward characteristic of Diode, Inverter (typical)

$I_F = f(V_F)$

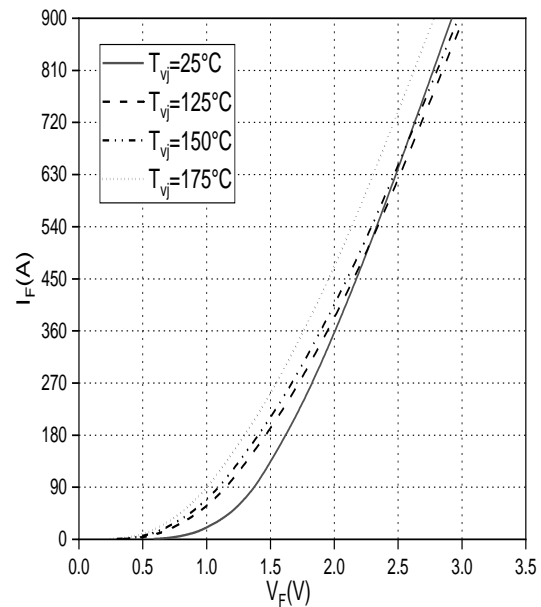

开关损耗二极管,逆变器 (典型值)
 Switching losses Diode, Inverter (typical)
 $E_{rec} = f(I_F)$
 $R_{Gon} = 1.0\Omega, V_{CE} = 600V$

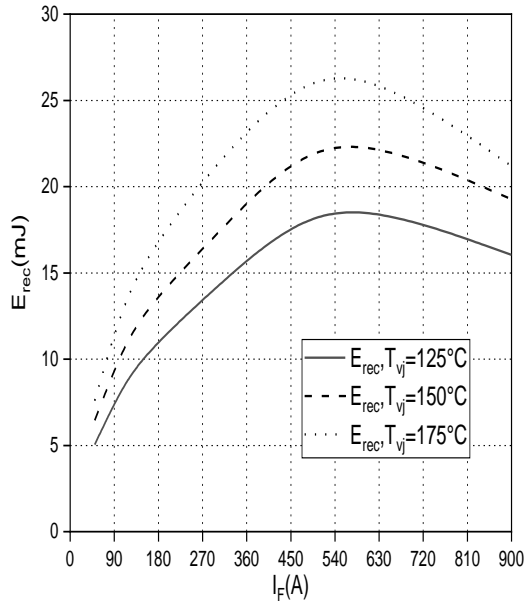

二极管,逆变器 (典型值)
 switching losses Diode, Inverter (typical)
 $E_{rec} = f(R_G)$
 $I_F = 450A, V_{CE} = 600V$

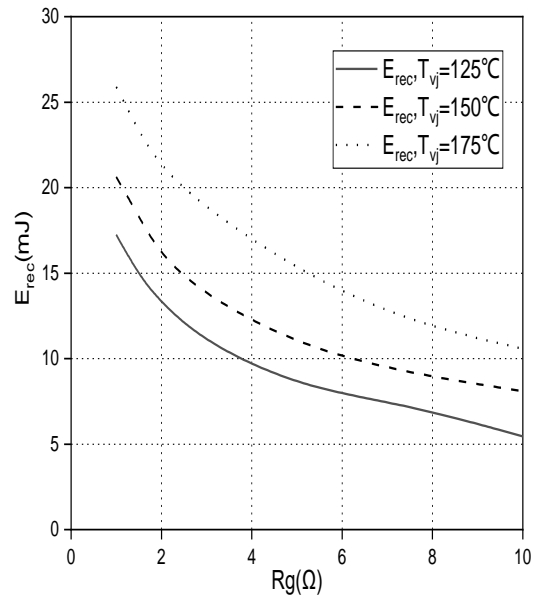

瞬态热阻抗二极管,逆变器
 transient thermal impedance Diode, Inverter
 $Z_{thJC} = f(t)$

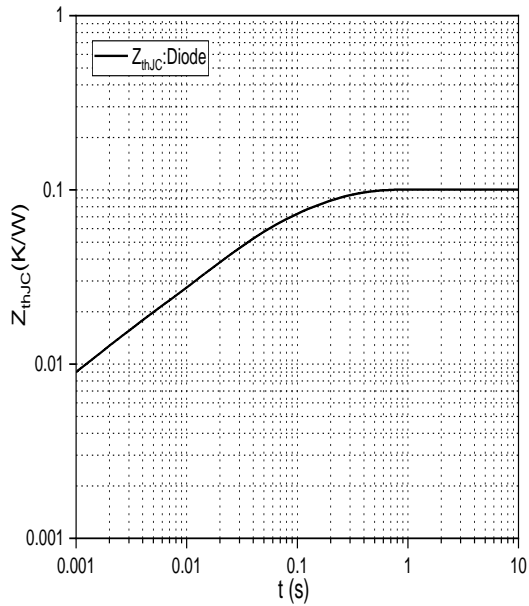

Internal Circuit:

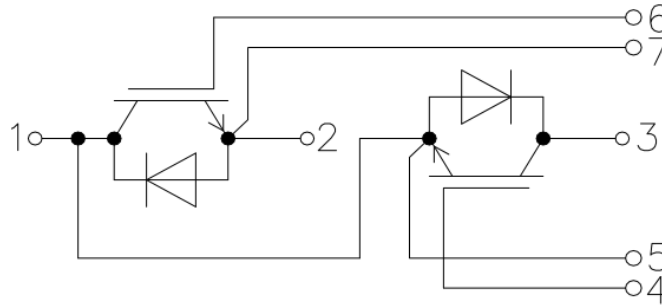

**Package Dimension
Dimensions in Millimeters**

